

Sonorous v2.0
by
Nel-Tech Labs, Inc.

Installation & User Manual

Index:

Introduction	3
Sonorous Layout Summary.....	4
Installation	5
Loading Files	6
CD Formatting and Creation	7
Troubleshooting	8
Specifications	9
Warranty & FCC	11

Introduction:

The Sonorous is a state-of-the-art digital audio recording and playback device designed to provide a continuous-play audio source for message-on-hold, background music, or any other audio application where high-quality audio playback is required. The audio program is loaded from a standard MP3 burned CD using a pure digital-to-digital transfer into a high-density flash memory file system. After audio is loaded, the CD can be removed and the audio is played from its 8 Ω or 600 Ω output jacks on the rear of the unit.

Unpacking and Inspection:

Before you begin installation, unpack and verify that you have all the correct parts.

- (1) Sonorous
- (1) 15VDC @ 1.67A power supply
- (1) Instruction manual and sample audio on CD ROM
- (1) RCA to RCA cable
- (1) 1/8" to RCA adapter
- (2) Wall mount screws
- (4) Rubber feet

If you are missing any of these parts STOP and call your dealer.

Sonorous Layout Summary:

Front of Unit

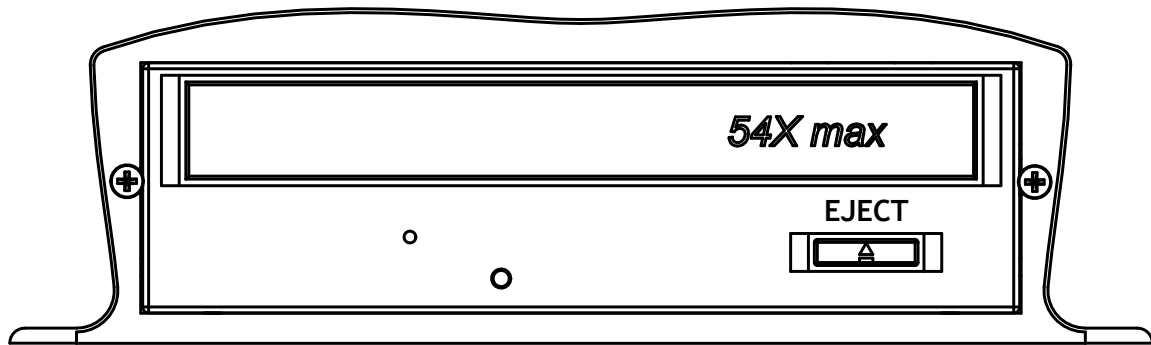

EJECT - This button opens/closes the CD ROM tray.

Rear of Unit

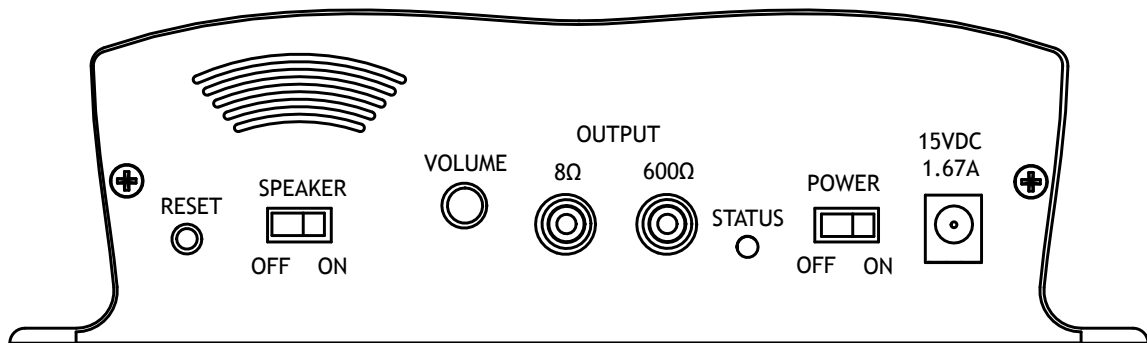

RESET - The RESET button clears audio stored on memory when held during power up. Note: Audio is automatically erased when changing CD media.

SPEAKER - The SPEAKER switch can be turned ON and OFF to monitor audio. The switch has no effect on the audio OUTPUT connections. Switch should normally be kept OFF.

VOLUME - This pot is used to control the output level of the stored messages. Volume up is clockwise, volume down is counter-clockwise.

OUTPUT - These RCA jacks supply the audio output to a MOH port, PA system or speaker.

STATUS - The STATUS indicator is a multi-colored LED that will indicate the current operation of the unit.

POWER - Use this switch to turn the unit ON and OFF.

15VDC - This is where the supplied 15VDC @ 1.67A power pack is connected.

Installation :

Step 1: Wall or shelf mount the unit. Screws and rubber feet are supplied in the accessory kit.

Step 2: Verify that the power switch on rear of unit is set to OFF. Attach the included power pack to a wall or power strip receptacle, then attach the other end to the jack on the rear of the unit labeled 15VDC.

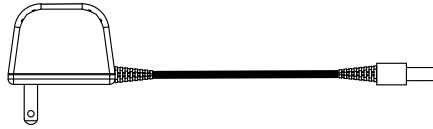

Step 3: If connecting unit to an amplifier make sure it is turned OFF for this part of the installation.

Step 4: Connect a RCA cable (supplied in the accessory kit) to the OUTPUT jack on the rear of the unit. Depending upon the required impedance use either the 8Ω or 600Ω output RCA jack. Connect the other side to an MOH port, PA system or speaker.



Step 5: Turn the power switch on rear of unit to the ON position. After the unit initializes the STATUS LED on the rear of unit will turn either SOLID GREEN if a message has been pre-loaded and is playing, or BLINK GREEN if no message is present. This process may take up to 30 seconds.

Step 6: If a message needs to be loaded then follow the loading instruction in this manual.

Step 7: Slide the SPEAKER switch located on the rear of the unit to the ON position. This speaker is for verifying audio playback and testing purposes only – DO NOT use this for setting the OUTPUT volume level!

Step 8: If any amplifiers or monitors were turned OFF during installation turn them back ON now.

Step 9: Adjust the volume level pot labeled VOLUME on the rear of the unit in conjunction with the monitor or amplifiers master volume to achieve a balanced but not over driven audio level.

Step 10: Slide the SPEAKER switch to the OFF position and installation is complete.

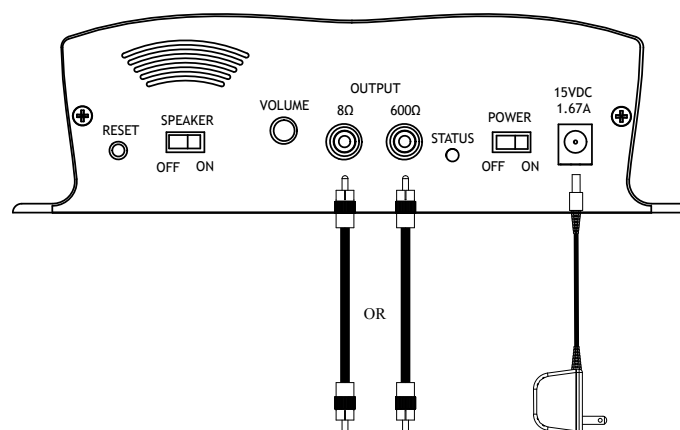

Wiring Diagram

Loading Audio Files to Sonorous:

Step 1: Verify that the unit has power and is turned on. If the unit is just being turned on allow about 30 seconds for it to initialize before going to next step.

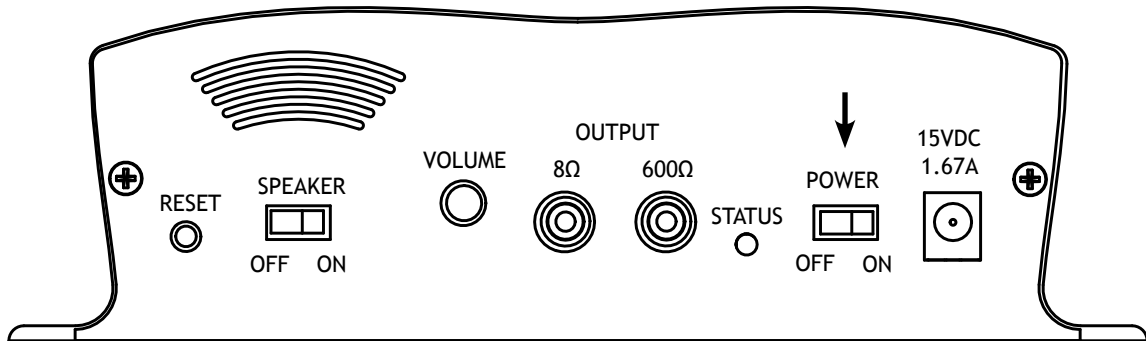

Step 2: Press the EJECT button on the front of the unit.

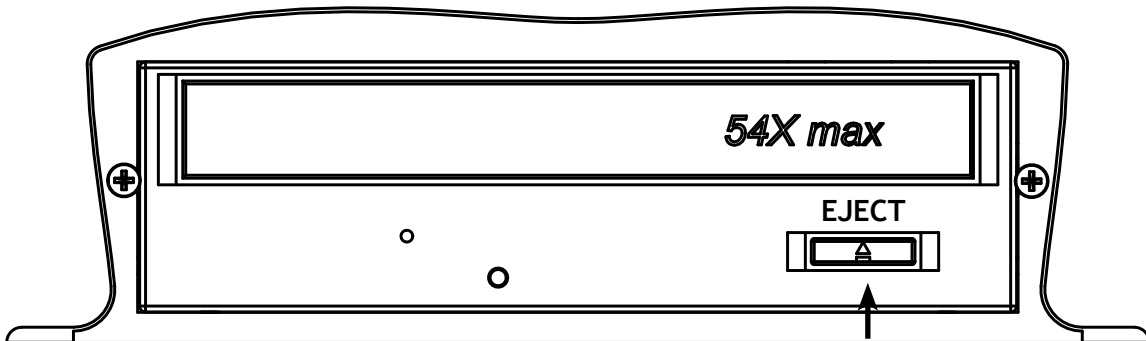

Step 3: Place a CD with MP3 files (formatted as a DATA CD, not an AUDIO CD) in the tray.

Step 4: Press the EJECT button or lightly push the drawer to close it.

Step 5: The Sonorous will load the audio files from the CD to its internal flash memory. While loading the STATUS LED will change from BLINKING ORANGE to a SOLID GREEN. If an invalid CD is encountered the Sonorous will automatically open the drawer and the STATUS LED will be BLINKING RED.



Step 6: Once completed the CD can be left in the unit or removed.

CD Formatting and Creation:

Since there are many different methods used to burn CD these instructions should be used as a guide.

Burning CD:

Step 1: Take a standard MP3 file and drag it over to the CD-ROM icon or folder to be burned.

Step 2: Burn the file to the CD as a DATA CD.

Step 3: Once file is burned always try it in a Sonorous unit before shipping.

Audio File Type:

The Sonorous utilizes a **MONO** file format. If a STEREO file is utilized it must be converted to MONO.

Multiple Files:

If multiple files are being burned to the CD it is good practice to edit the audio before hand so there is a small amount of fade-in and fade-out. Adding these fades will give the audio playback better continuity between messages.

If files are required to be played back in a certain order then number them using a 3-digit number. For example: 100testfile.mp3, 101testfile.mp3, 102testfile.mp3, etc.

Sonocrypt :

The Sonocrypt feature is beyond the scope of this Users Manual. If Sonocrypt is utilized please contact your dealer for more information.

Technical Notes:

Windows XP - Make sure DATA CD is selected when asked. The CD is burned using a CDFS (CD File System) and is compatible with all versions of Sonorous.

Windows Vista - Make sure LIVE FILE SYSTEM (DATA CD) is selected when asked. The CD is burned using a UDF (Universal File System) and is only compatible with Sonorous v2.0 and above. CD burned using this method and used in a Sonorous v1.0 will not work.

3rd Party Programs - Most 3rd part programs allow a DATA CD to be burned with the CDFS formatting. Using the CDFS formatting system is the best and most reliable method since it is compatible with all versions of Sonorous.

Troubleshooting:

Problem	Possible Reason
Status LED - OFF	Power on rear of unit OFF Power pack not plugged in or on a switched outlet
Status LED - SOLID GREEN	Unit is playing audio file
Status LED - BLINKS GREEN SLOW	No audio on unit
Status LED - BLINKS GREEN FAST	Unit ran out of memory while loading audio (but still will play the files that did successfully load)
Status LED - BLINKS ORANGE	Unit is loading files from CD ROM Unit is formatting file system
Status LED - BLINKS RED	Files are not valid CD not valid (must be DATA, not AUDIO CD) Trying to play files on an encrypted unit
Playback in wrong order	Check naming of files
Skipping over files	File not compatible with unit
Popping audio	File was encoded using too high of a bit-rate File incompatible with unit File audio starting too close to beginning of file

Note: Some audio editors embed album art or cover art into the MP3 files.
Some of these files may not be compatible with Sonorous.

Sonorous Specifications:

Audio Decoding

MP3 (MPEG-3) audio playback
8K to 128Kbps bit rate
16KHz to 44KHz sample rate

Memory Type

High Density NAND Flash

Memory Capacity

16MB

File Capacity

Up to 512 files (depending on size of files)

Audio Output

RCA jack, 6V p-p @ 8 Ω , 3v p-p @ 600 Ω

Message Loading

CD ROM formatted as DATA CD (CDFS and UDF file systems supported)

Message Playback

Continuous

Power Requirements

15VDC @ 1.67A, typical

Environmental

0°C to 50°C, 5% to 95% relative humidity, non-condensing

Size

2.25" x 7.50" x 8.75" (H x W x D)

Shipping Weight

5 pounds

Limited Warranty

TERMS: Nel-Tech Labs warrants to the original purchaser (“Buyer”) that the Product sold is free from defects in material and workmanship at the time of purchase. The warranty period begins at the time of Product’s original purchase by the first end-user. The warranty applies for five (5) year from the original date of purchase, or as long as the product is owned by the original purchaser, whichever comes first. Included in the warranty are parts and labor. Buyer must provide written notice to Nel-Tech Labs of any defective part or conditions within the warranty period. If the defect is not the result of improper use, service, maintenance or installation, and if the equipment has not been otherwise damaged or modified after shipment, Nel-Tech Labs or its authorized representative shall either replace or repair the defective Product at Nel-Tech Labs’s option. No credit shall be allowed for work performed by Buyer or unauthorized parties. Out-of-warranty repairs are invoiced at the current Nel-Tech Labs hourly rate plus the cost of parts, shipping and handling. In the event that the product serial number is missing or has been tampered with in any way, the foregoing warranty is void and without effect and Nel-Tech Labs shall have no liability whatsoever on account of defects to such product.

LIMITATIONS: Except as stated above, there are no warranties, express or implied, that extend beyond the specifications for the product. Nel-Tech Labs expressly disclaims any warranty, express or implied, that equipment sold hereunder is of merchantable quality or that it can be used, or is fit for any particular purpose. Buyer purchases and accepts equipment solely on the basis of the warranty here in above expressed. Under no circumstances shall Nel-Tech Labs be liable by virtue of this warranty or otherwise for any special indirect, secondary or consequential damages to any person or property arising out of the use or inability to use the product.

REPAIRING OR REPLACING PRODUCT: Buyer may obtain the repair or replacement of any eligible part or equipment covered under this warranty through a Nel-Tech Labs dealer only. Buyer is responsible for all shipping and handling charges in connection with the performance of this warranty. Products returned to Nel-Tech Labs must be securely packaged to prevent damage in transit, freight prepaid, and insured for replacement value. A return authorization number assigned by Nel-Tech Labs must be clearly marked on the outside of the shipping container. Proof of purchase must accompany shipment. Items delivered to Nel-Tech Labs without a return authorization clearly marked on the outside of the shipping container, and/or without proof of purchase is refused.

CONTACT: Please contact Nel-Tech Labs at the address and phone number below to receive a return authorization number and to arrange for the repair or replacement of a flawed part covered by this warranty. Please indicate the Product’s serial number in all correspondence or a RMA authorization number in the absence of a serial number. Nel-Tech Labs, 4 Ash Street Extension, Derry, NH 03038, Phone: 1.603.425.1096.

COPYRIGHT NOTICE: The Nel-Tech Labs, Inc. Sonorous is strictly used for licensed content only. Use of copyrighted content is illegal and Nel-Tech Labs, Inc. takes no responsibility for that action.

FCC Part 15 : This equipment has been tested and found to comply within the limits for a Class A digital device, pursuant to Part 15 of the FCC rules. These limits are designed to provide reasonable protection against harmful interference when the equipment is operated in a commercial environment. This equipment generates, uses and can radiate radio frequency energy and, if not installed and used in accordance with the instruction manual, may cause harmful interference to radio communications. Operation of the equipment in a residential area is likely to cause harmful interference in which case the user will be required to correct interference at his own expense. In order to maintain compliance with FCC regulations shielded cables must be used with this equipment. Operation with non-approved equipment or unshielded cables is likely to result in interference to radio & television reception.

Changes or modifications not expressly approved by Nel-Tech Labs could void the users’ authority to operate the equipment.

IC ES 003 : This Class A digital apparatus complies with Canadian ICES-003 C et appareil numérique de la classe A est conforme à la norme NMB-003 du Canada.

CE CONFORMITY : The Nel-Tech Labs Sonorous conforms with the following standards, in accordance with the EU Safety, EMC Emissions, & EMC Immunities : EN 60950-1:2001, EN 55022:1998 for Class A, EN 55024:1998 + A1:2001 + A2:2003, EN 61000-4-2:1995 + A1:1998, EN 61000-4-3:1995, EN 61000-4-4:1995, EN 61000-4-5:1995, EN 61000-4-6:1996, EN 61000-5-11:1994.



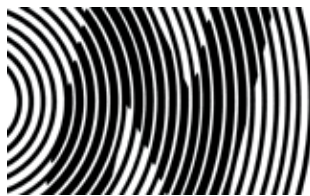

Nel-Tech Labs, Inc.
4 Ash Street Extension
Derry, NH 03038

1.800.344.4685
www.nel-techlabs.com

Rev. B - 07/08

Copyright © 1984 - 2008 by Nel-Tech Labs, Inc.